

CASING ROTATOR



www.bumace.com

Trust cannot be replaced



BUMA CE CO., LTD.
BUMA Construction Equipment

Casing Rotator Method

Cased Drilled Shafts are necessary when ground conditions are so unstable that drilled holes cannot be safely stabilized with drilling slurry or when the loss of ground must be controlled. Casings can consist of either temporary or permanent steel pipes, offering 100% stable excavation along the entire length of the drilled shaft.

The Casing Rotator method represents a superior approach to constructing drilled shafts, ensuring high quality and maintaining an uninterrupted construction schedule by eliminating anomalies.

This technology stands as the sole proven method for drilling large-diameter shafts in caving conditions, such as loose sands and gravelly soil containing cobbles and boulders. Boulders measuring several feet in diameter can be safely removed using tools like the Hammer Grab or Spherical Grab, minimizing significant interruptions to the excavation process. As only water is employed in the drilling process, environmental concerns are mitigated or even eliminated through the utilization of this technique.



Working Procedure

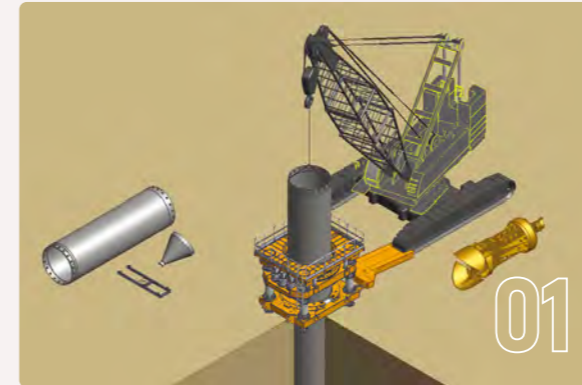

01 Install starter casing equipped with cutting shoe. Add new casing section with bolted connection.

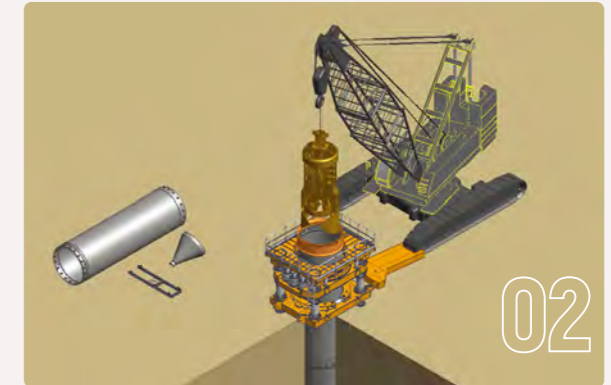

02 Excavate soil continuously during casing installation. Maintain water head inside casing to balance external hydrostatic head at all times.

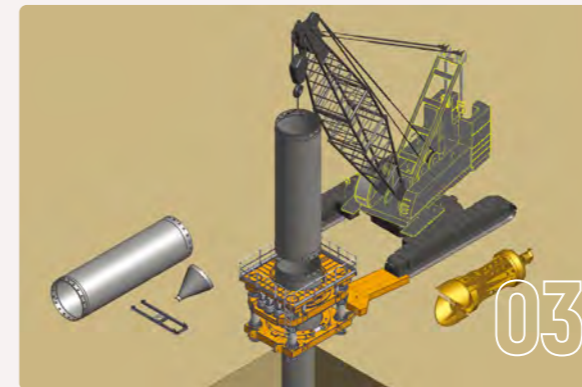

03 Add new casing sections until pile has been excavated to depth. Keep casing tip ahead of excavation at all times.

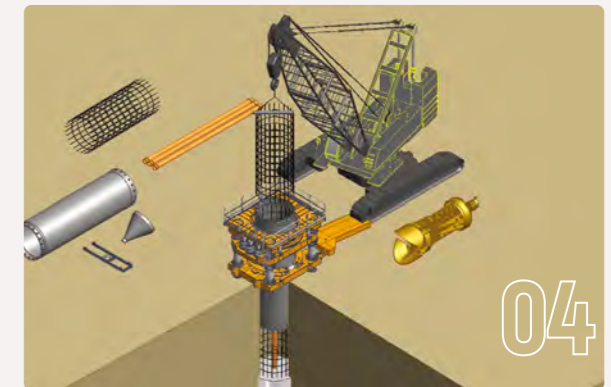

04 Install reinforcement cage and suspend at proper elevation.

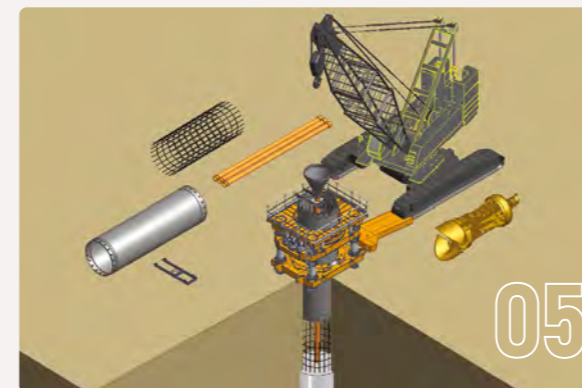

05 Pour concrete using sectional tremie pipe. Maintain concrete head above casing tip at all times.

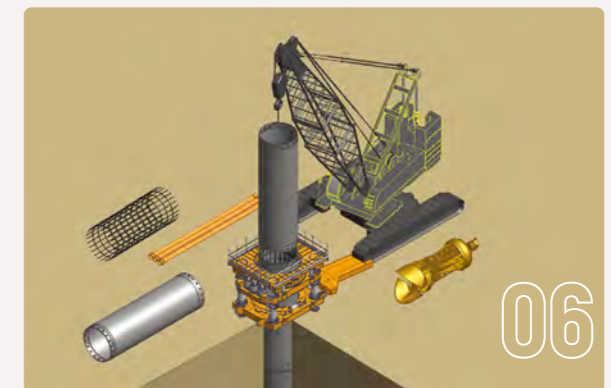

06 Remove casing and tremie pipe sections simultaneously as concrete is poured.

Various Applications



- Removing existing concrete piles



- Cutting through concrete in secant piling

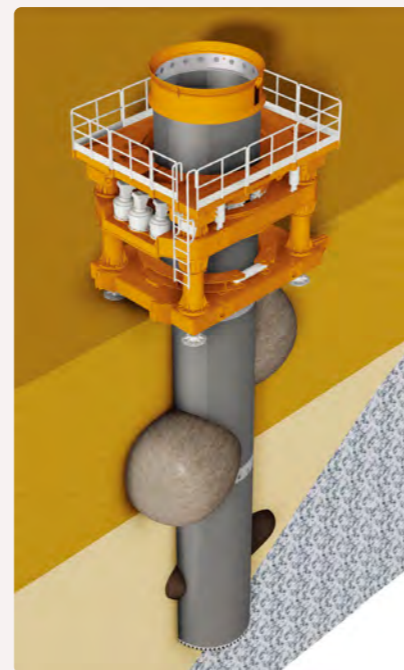

- Penetrating inclined rock layers or large boulders

BM-CR1500

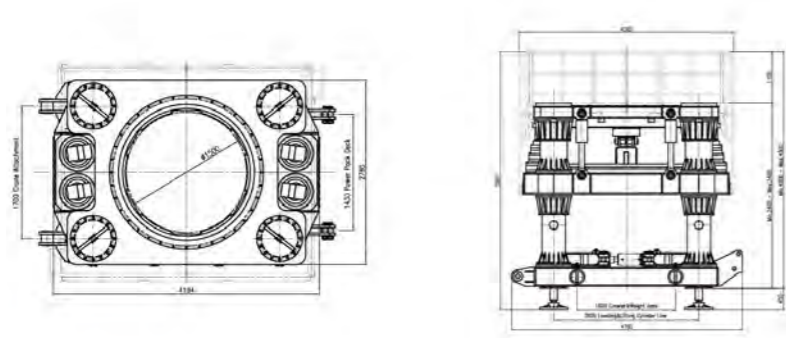

Specification

Applicable Casing Diameter	800 ~ 1,500 mm (2'7" ~ 4'11")
Torque	2,125 kN.m (1,567,319 lbf.ft), Boost : 2,720 kN.m (2,006,168 lbf.ft)
Rotation Speed	0 ~ 2.65 rpm
Extracting Force	211 ton at 320 bar, 4 Hyd. Cylinder (Stroke 750 mm / 2'6")
Weight	30 ton Approx. (66,139 lb)
Power Pack	P2616CR / P3816CR (TIER IV) / P3616CR (TIER III)

** The specifications are subject to change for improvements or customer's requirement

Dimension

Length	4,700 mm (15'5")
Width	3,300 mm (10'10")
Height	2,400 mm (7'10")
Max. Height	3,400 mm (11'2")

BM-CR2500

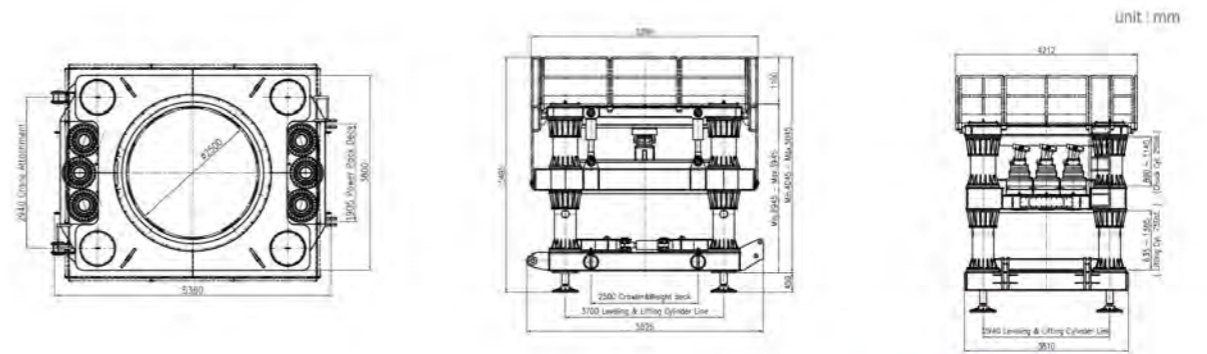

Specification

Applicable Casing Diameter	1,500 ~ 2,500 mm (4'11" ~ 8'2")
Torque	5,156 kN.m (3,802,870 lbf.ft), Boost : 6,600 kN.m (4,867,909 lbf.ft)
Rotation Speed	0 ~ 2.34 rpm
Extracting Force	486 ton at 320 bar, 4 Hyd. Cylinder (Stroke 750 mm / 2'6")
Weight	64 ton Approx. (141,096 lb)
Power Pack	P6125VR (TIER IV) / P6025CR (TIER III)

** The specifications are subject to change for improvements or customer's requirement

Dimension

Length	5,525 mm (18'2")
Width	4,212 mm (13'10")
Height	2,945 mm (9'8")
Max. Height	3,945 mm (12'11")

BM-CR2000

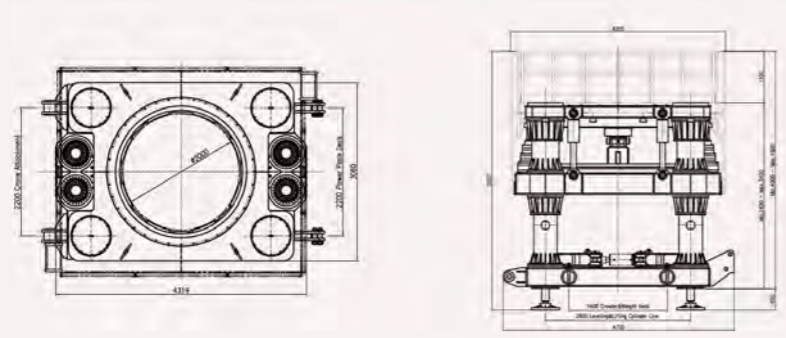

Specification

Applicable Casing Diameter	1,000 ~ 2,000 mm (3'3" ~ 6'7")
Torque	3,188 kN.m (2,351,344 lbf.ft), Boost : 4,081 kN.m (3,009,986 lbf.ft)
Rotation Speed	0 ~ 2.25 rpm
Extracting Force	363 ton at 320 bar, 4 Hyd. Cylinder (Stroke 750 mm / 2'6")
Weight	42 ton Approx. (92,294 lb)
Power Pack	P3816CR (TIER IV) / P3616CR (TIER III)

** The specifications are subject to change for improvements or customer's requirement

Dimension

Length	4,875 mm (16'0")
Width	3,600 mm (11'10")
Height	2,927 mm (9'7")
Max. Height	3,877 mm (12'9")

BM-CR3000

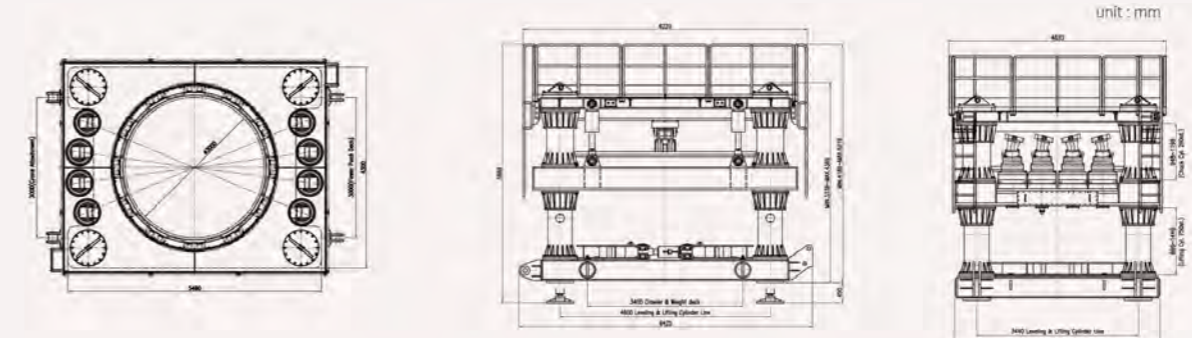

Specification

Applicable Casing Diameter	2,000 ~ 3,000 mm (6'7" ~ 9'10")
Torque	7,162 kN.m (5,282,419 lbf.ft), Boost : 9,167 kN.m (6,761,231 lbf.ft)
Rotation Speed	0 ~ 1.8 rpm
Extracting Force	532 ton at 320 bar, 4 Hyd. Cylinder (Stroke 750 mm / 2'6")
Weight	82 ton Approx. (180,779 lb)
Power Pack	P6125VR (TIER IV) / P6025CR (TIER III)

** The specifications are subject to change for improvements or customer's requirement

Dimension

Length	6,425 mm (21'1")
Width	4,620 mm (15'2")
Height	3,339 mm (10'11")
Max. Height	4,369 mm (14'4")

BM-CR3500

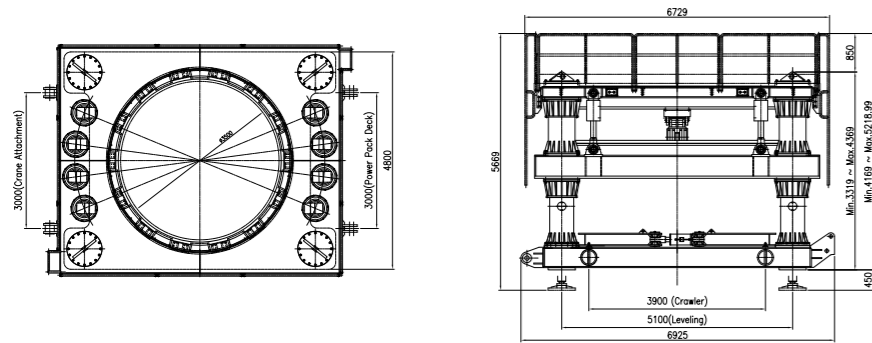

Specification

Applicable Casing Diameter	3,000 ~ 3,500 mm (9'10" ~ 11'5")
Torque	8,000 kN.m (5,900,496 lbf.ft), Boost : 10,200 kN.m (7,523,133 lbf.ft)
Rotation Speed	0 ~ 0.9 rpm
Extracting Force	788 ton at 320 bar, 4 Hyd. Cylinder (Stroke 750 mm / 2'6")
Weight	100 ton Approx. (264,554 lb)
Power Pack	P6125VR (TIER IV) / P6025CR (TIER III)

** The specifications may be subject to change to enhance performance or meet specific customer requirements.

Dimension

Length	6,925 mm (22'8")
Width	5,109 mm (16'9")
Height	3,319 mm (10'10")
Max. Height	4,369 mm (14'4")

Power Pack

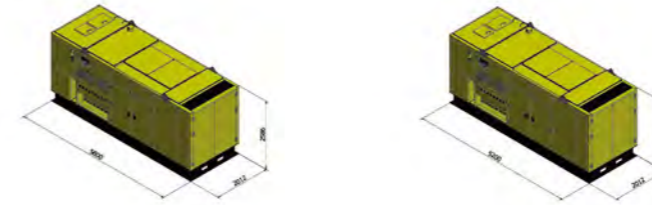

BM-P2616CR & BM-P3816CR & BM-P3616CR

BM-P6025CR & BM-P6125VR & BM-P7625CR



Specification

Model		BM-P2616CR	BM-P2616CR	BM-P3616CR	BM-P6125VR	BM-P6025CR	BM-P7625CR
Engine	CU mmINS QSB 6.7 (TIER 4)	CU mmINS QSL9 (TIER 4)	CU mmINS QSM 11 (TIER 3)	VOLVO TAD1671VE (TIER 4)	CU mmINS QSX-15 600 (TIER 3)	CU mmINS QSK-23 (TIER 3)	
	210 kW	283 kW	268 kW	450 kW	447 kW	567 kW	
	260 HP	380 HP	360 HP	612 HP	600 HP	760 HP	
		2,100 rpm		1,900 rpm	2,100 rpm		
Hyd. Pump	Max. Flow	330 l/min x 2ea			450 l/min x 2ea		525 l/min x 2ea
	Operating	250 bar / Max. 320 bar					
Weight		8 ton	9 ton	9.5 ton	11 ton	11 ton	13.5 ton

** The specifications may be subject to change to enhance performance or meet specific customer requirements.

BM-CR4000

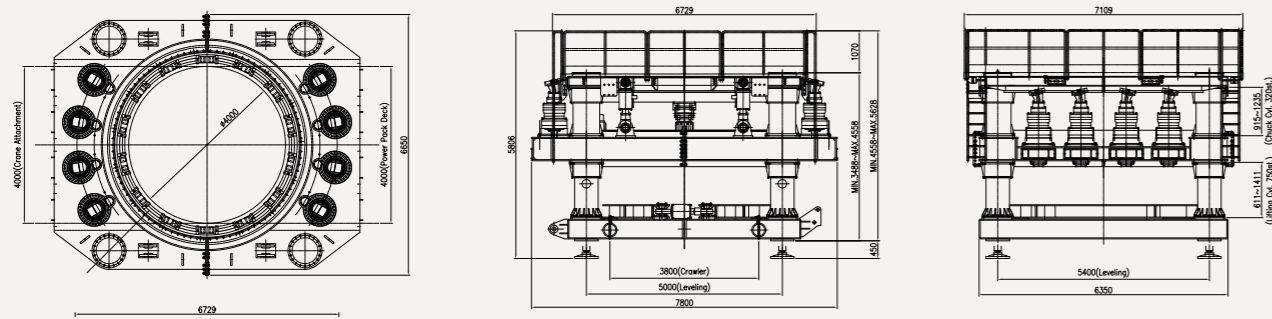

Specification

Applicable Casing Diameter	3,500 ~ 4,000 mm (11'5" ~ 13'1")
Torque	8,250 kN.m (6,084,887 lbf.ft), Boost : 10,560 kN.m (7,788,655 lbf.ft)
Rotation Speed	0 ~ 1.5 rpm
Extracting Force	905 ton at 320 bar, 4 Hyd. Cylinder (Stroke 750 mm / 2'6")
Weight	120 ton Approx. (264,554 lb)
Power Pack	P7625CR (TIER T3)

** The specifications may be subject to change to enhance performance or meet specific customer requirements.

Dimension

Length	7,800 mm (25'7")
Width	7,100 mm (23'3")
Height	3,488 mm (11'5")
Max. Height	4,558 mm (14'11")

Special Accessories

Main Control in Power Pack



Wireless Main Remote Control



Wireless Traveling Remote Control



Operating conditions, including leveling, rotation speed, torque, and hydraulic pressure, can be monitored in real-time, and control parameters can be adjusted using the touchscreen interface on the main remote control.

Casing Clamping Chuck



Retaining Clamp



Special Features

Counter Balance Function

The Counter Balance Function involves the Rotator holding the total weight load of the casing, thereby ensuring stable casing drilling conditions. Through the manipulation of casing weight, thrust force, and rotation speed, the rotator can effectively drive the casing. This function proves essential when drilling into inclined rock layers and when performing overlap cutting in secant pile construction.



Automatic Clamping Function

This function prevents the casing from dropping during the lifting process of the Rotator. The system is programmed to retain (lower) the clamp until the upper clamp (chuck) is securely engaged, and vice versa.



Automatic Oscillating Function

Similar to the Casing Oscillator found in some of BUMA's rotators, the automatic oscillating function helps release the casing from friction with the surrounding soil in case of interruptions.



Self Traveling

By utilizing optional crawler tracks and a power pack deck, the need for a crane to lift the heavy rotator is eliminated. This feature reduces mobilization time when moving the equipment from one shaft to another.



Automatic Driving Function

The Automatic Driving Function is a programmed sequence of operations that enables the machine to navigate autonomously, allowing for smart movement without operator intervention.



Automatic Pull-Down Force Control Function

This function allows the casing to calculate the pressure applied to the ground and adjust it according to the operator's settings, ensuring controlled and precise drilling.



Torque Booster Function

The Torque Booster Function temporarily increases system pressure to the maximum permissible level when high rotational torque and lifting force are required during operation, thereby maximizing power output.



Wireless Communication System

The Wireless Communication System enables real-time monitoring of field work information from the rotor in the field office within a certain range, enhancing communication and data access during operations.

Honolulu RAIL Transit Project

Honolulu HI, USA

Casing Diameter :
Ø 3,000 mm, Ø 2,200 mm

Casing Driving : 57 m

Equipment : CR3000



Gerald Desmond Bridge Replacement Project

Long Beach CA, USA

Casing Diameter :
Ø 2,500 mm, Ø 1,800 mm,
Ø 1,500 mm
Casing Driving : 55 m
Equipment : CR2500



Thomsoon Line Project

Singapore, Singapore

Casing Diameter :
Ø 1,300 mm, Ø 1,400 mm
Casing Driving : 25 m
Equipment : CR2500





109, Techno valley 1-Ro, Jillye-Myeon, Gimhae-city, Gyeongsangnam-Do, Republic of Korea

Tel. +82-55-337-9891~3

Fax. +82-55-337-9894

Email. cesales@bumace.com

Web. www.bumace.com

©BUMA CE Co., Ltd. All right reserved. 2023



VER. 03.ENG.